

SuperPak™
SuperPak™
SuperPak™
SuperPak™
SuperPak™
SuperPak™
SuperPak™

User's Manual

AST RESEARCH INC.

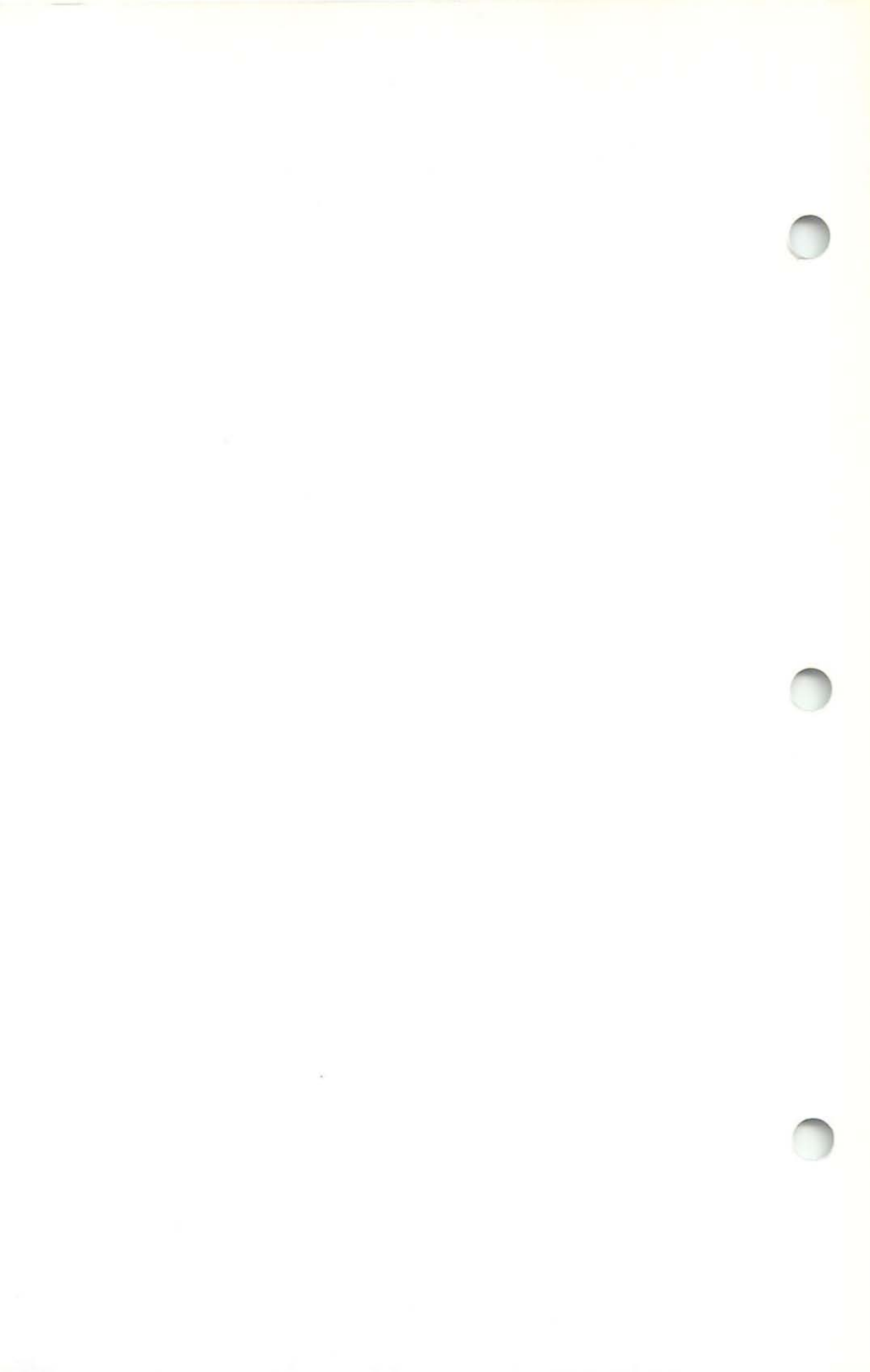

SuperPak™

User's Manual
000114-001 B
May, 1984

AST RESEARCH, INC.
Irvine, California 92714
(714) 863-1333

SECOND EDITION (May 1984)

IBM is a registered trademark of International Business Machines Corp.

SuperPak, SuperDrive, and SuperSpool are trademarks of AST Research, Inc.

Changes are periodically made to the information contained in this manual; these changes will be incorporated into new editions.

A Product Comment Form is provided at the back of this publication. If this form has been removed, please address your comments to: AST Research, Inc., 2121 Alton Avenue, Irvine CA 92714. AST Research may use or distribute any of the information you supply in any way it deems appropriate without incurring any obligations whatsoever.

Copyright © 1984 AST Research, Inc. All rights are reserved, including those to reproduce this book or parts thereof in any form without permission in writing from AST Research, Inc.

TABLE OF CONTENTS

SECTION 1. INTRODUCTION	1-1
1.1 This Manual	1-2
1.2 Syntax Conventions	1-2
1.3 Copying SuperPak Programs	1-3
SECTION 2. SUPERDRIVE	2-1
2.1 Introduction	2-1
2.2 Preparing Your PC	2-2
2.3 The SUPERDRV Command	2-4
2.3.1 Drive Selection and Configuration Parameters	2-4
2.3.2 Memory Allocation Parameters	2-5
2.3.3 Number of Sectors Per Track	2-8
2.4 SuperDrive Examples	2-8
2.5 SuperDrive Application Notes	2-11
2.5.1 Using SuperDrive with Overlay Software	2-11
2.5.2 Protecting Important Data Files	2-12
2.5.3 Creating SuperDrive A: from an AUTOEXEC File	2-13
2.5.4 Single Drive Systems	2-13
2.5.5 Using DOS Commands With SuperDrive	2-14
2.5.6 SuperDrive Compatibility	2-15
2.6 SuperDrive Example	2-16
2.7 Error Messages	2-17
SECTION 3. SUPERSPOOL	3-1
3.1 Introduction	3-1
3.2 Preparing PC-DOS for SuperSpool	3-2
3.3 The SUPERSPL Command	3-3
3.3.1 Specifying the Output Port	3-3
3.3.2 Serial Printer Configuration Parameters	3-4
3.3.3 Memory Allocation Parameters	3-5
3.3.4 Printer Format and Secondary Options	3-7
3.4 SuperSpool Examples	3-9
3.4.1 SuperSpool Parallel Printer Examples	3-9
3.4.2 SuperSpool Serial Printer Examples	3-10

TABLE OF CONTENTS

(Continued)

3.5 SuperSpool Secondary Commands	3-11
3.5.1 Page Reprint Options	3-12
3.5.2 Determining SuperSpool Status	3-13
3.5.3 Changing Printer Configuration	3-13
3.5.4 Secondary SuperSpool Examples	3-13
3.6 SuperSpool Compatibility	3-14
3.7 SuperSpool Utility Batch Files	3-15
3.8 SuperSpool Example	3-16

SECTION 4. SUPERDRIVE AND SUPERSPOOL: RULES FOR USE	4-1
--	------------

SECTION 5. MEMORY ALLOCATION	5-1
5.1 Memory Allocation Examples	5-2

SECTION 6. RAMCLEAR	6-1
----------------------------------	------------

APPENDIXES

APPENDIX A. GUIDE TO TERMINOLOGY	A-1
APPENDIX B. PATCHING DOS FOR ADDITIONAL DRIVES	B-1

SECTION 1

INTRODUCTION

This manual describes tells you how to use the programs on your SuperPak™ diskette. Although these programs were designed to take full advantage of the special capabilities of AST Research, Inc., expansion cards, they should work satisfactorily on most other expansion cards available for the IBM® PC-1, PC-2, PC-XT, or Portable PC. They function under PC-DOS 1.1 and 2.x (2.0 and subsequent versions). They do not operate under any other operating systems.

SuperDrive™ (SUPERDRV.COM) is a program which simulates disk drives within the Random Access Memory (RAM) of your system. This enables you to retrieve and store data and command (program) files much faster than the usual mechanical disk acquisition and transfer time allows.

SuperSpool™ (SUPERSPL.COM) is a program which outputs data to a printer while permitting you to simultaneously perform other tasks on your PC. Your print output is stored in a predefined area of memory and "clocked out" using PC interrupt timing. The microprocessor is freed from having to waste its valuable processing time waiting for the printer. This means your PC can execute other software in the "foreground" while the printing of data is handled by SuperSpool in the "background".

RAMCLEAR is a program which initializes areas of memory above the switch settings to avoid false parity errors.

The *Clock-Calendar* feature sets the time and date for you every time you turn on or reboot the computer. The *User's Manual* for your AST Research product describes its Clock-Calendar programs.

1.1 This Manual

The SuperPak utility programs will save you time and effort when installed and used properly. Read the instructions in this manual carefully to familiarize yourself with SuperPak's capabilities.

1.2 Syntax Conventions

The following conventions are used in this manual to present command statement formats:

1. A syntax element written in **uppercase letters or special symbols other than brackets, braces, or ellipses** is a keyword and must be entered exactly as shown. Keywords can be entered in any combination of upper- and lowercase letters.
2. **Square brackets ([])** indicate an optional term which is included or omitted at the user's discretion. The brackets are not part of the input.
3. **Braces ({ })** indicate that the user must choose one of the items that are enclosed within the braces.
4. **Lowercase letters** represent user-defined parameters. These parameters must satisfy the conditions specified in the command description.
5. You do not need to press the <Enter> key unless explicitly stated in this manual.
6. The notation <F6> indicates that you should press function key F6 located at the left side of the keyboard.

Appendix A contains a short glossary of certain technical terms this manual uses to describe SuperPak's operation and capabilities.

1.3 Copying SuperPak Programs

The SuperPak utility diskette is a formatted, single-sided, eight-sector data diskette with no DOS on it. This makes it compatible with the COPY function of DOS 1.1 and 2.x. The following steps tell you how to copy it; you may also want to refer to the discussion of the COPY command in your IBM DOS manual.

Step 1

Put a write-protect tab on the SuperPak diskette. This will prevent accidental erasure during the copying process.

Step 2

Boot the system with your DOS diskette. This should be a working copy of DOS and not the original master diskette.

Step 3a

If you have only one floppy drive, enter:

```
COPY B:*. * A:<Enter>
```

The system will prompt you to swap between the DOS diskette (diskette A:) and the SuperPak diskette (diskette B:).

Step 3b

If you have two or more floppy drives, place the SuperPak diskette in drive B: and enter:

```
COPY B:*. * A:<Enter>
```

Step 4

This procedure copies over the SuperPak utility programs to your working DOS diskette. You can then copy them over individually to your other diskettes, as necessary. Keep your SuperPak master diskette in a safe place and do not use it during routine computer operations.

(This page intentionally left blank)

SECTION 2

SUPERDRIVE

SuperDrive™ © Copyright 1983 AST Research, Inc.

This software has been provided pursuant to a License Agreement containing restrictions on its use. The software contains proprietary information of AST Research, Inc., and is protected by federal copyright law. It may not be copied and distributed in any form or medium without prior written permission from AST Research, Inc.

NOTE

The information contained in this section applies to SuperPak version 4.1 (or subsequent) and SuperDrive 1.30 (or subsequent). SuperDrive 1.30 (or later) is *not* compatible with the pre-1.30 SuperSpool program.

2.1 Introduction

The SuperDrive electronic disk program can greatly enhance the processing speed of your IBM Personal Computer (PC). You can now assign RAM space for use as up to four SuperDrive electronic disk drives and retrieve data or programs at "RAM speeds," much faster than a mechanical disk would allow.

You can think of SuperDrive as a super-fast floppy disk drive. Once it has been created, you can COPY to it or COPY from it, ERASE files from it, run CHKDSK on it, or perform just about any other legal DOS command with it. However, because SuperDrive is a program, just like a word processor or general ledger program, it must be "set up" each time you turn on the computer, and it will "go away" whenever the computer is turned off.

SuperDrive includes these features:

- Allows simulation of up to four electronic disk drives
- Allows an electronic disk drive to be inserted between existing physical disk drives
- Allows you to define the size of program memory space and electronic disk memory spaces
- Allows you to restrict SuperDrive operation to specific areas of memory
- Supports single- and double-sided electronic drives, eight or nine sectors per track, up to 360K in size
- Is compatible with IBM PC-DOS and the IBM hard disk system

2.2 Preparing Your PC

NOTE

If you have only one drive, you must copy the SuperPak software to your DOS diskette before you reset the system board switches (Subsection 1.2 tells you how to copy your SuperPak diskette).

This section tells you how to prepare your PC for SuperDrive operation. (Appendix B presents an alternative procedure.) Normally, you will have to do this only once. After you have set up the PC as described below, no further hardware preparation is necessary.

PC System Board Switch #1—System board switch #1 positions 1, 7, and 8 are used in all versions of the PC, including the XT, to tell the computer how many floppy diskette drives are present. Since a SuperDrive is treated just like any other floppy drive, these switches must be set to reflect the total number of drives, including SuperDrives.

EXAMPLE: Refer to the chart below. If there is currently one floppy drive in your PC, system board switch #1 positions 7 and 8 will probably be ON (position 1 on the switch is always OFF). If you intend to use two SuperDrive disk drives in addition to your floppy drive, you must tell the computer you have three drives, which would be position 7 ON and position 8 OFF. (In the following table, "S-Drive" means SuperDrive.)

Switch #1 on the System Board of all PCs Including XT
(not the switch on the AST card)

Total No. of Drives	System Board Switch #1			Possible Floppy and/or S-Drive Designations	IBM Fixed Disk Designations*
	1	7	8		
1	OFF	ON	ON	A: (NO S-DRIVE)	C: etc.*
2	OFF	OFF	ON	A: B:	C: etc.*
3	OFF	ON	OFF	A: B: C:	D: etc.*
4	OFF	OFF	OFF	A: B: C: D:	E: etc.*

* Applies only to computers equipped with the IBM fixed disk, such as the XT, and should be ignored by other users. In the XT, the switch setting refers to the total number of floppy drives and SuperDrives only. The IBM fixed disk is *excluded* from this total. SuperDrive should not be used with other hard disk systems.

You can leave the switches set for a total of three or four drives, even if you don't intend to always run with that many floppy drives and/or SuperDrives, or even if you occasionally work without SuperDrive. Of course, the system would then think there really are three or four drives and would accept commands the operator might issue to the nonexistent drives. If this happens, the system is smart enough to recover from the error and will give the user an opportunity to abort the operation. To avoid false errors when running the IBM diagnostics, you will probably want to set the switches back to the real number of drives in your system.

2.3 The SUPERDRV Command

Because SuperDrive is a program, just like a word processor or general ledger program, it must be initialized each time you turn on your PC. This section describes in detail the various commands and options you can use and the format in which they must be entered. Section 2.6 gives a step-by-step example of the actual process for creating a SuperDrive.

To invoke the SuperDrive program (after your system has been properly prepared; see previous section, 2.2), type in a command using this format:

```
SUPERDRV n:[/1][/2][/1][/U = xxx][/M = xxx][/DH][/DL][/DNC]  
[/DMMGMT][/8] <Enter >
```

Note that each optional parameter is preceded by a slash (/). Do not use a space or commas to separate options.

The SUPERDRV command invokes the SuperDrive program's command handler routines (SUPERDRV.COM must be resident on your DOS diskette). The remainder of the command syntax specifies the various options. These options are described in the following three sections.

2.3.1 Drive Selection and Configuration Parameters

- n*: Denotes the drive to be simulated in RAM and is immediately followed by a colon. The only valid drive letters are A:, B:, C:, or D:.
- [/1]* Creates a single-sided drive. Under DOS 1.1, the default size for a single-sided drive is 160K. Under DOS 2.0 and 2.1, the default size for a single-sided drive is 180K. To specify a nonstandard capacity, see the /M = xxx option in Section 2.3.2.

- [/2] Creates a double-sided drive. If you do not use the /1 or /2 options, the program assumes you want to create a double-sided drive. Under DOS 1.1, the default size of a double-sided drive is 320K. Under DOS 2.0 and 2.1, the default size of a double-sided drive is 360K. For a nonstandard capacity, see the /M=xxx option in Topic 2.3.2.
- [/I] This parameter logically inserts a SuperDrive as drive n:. Any physical disk drive or SuperDrive currently defined as drive n: will be "pushed up" one drive position. For example:

SUPERDRV A:/I

causes drive A: (whether a SuperDrive or a floppy drive) to become drive B:, drive B: becomes drive C:, etc. Other drives which come logically after the inserted drive will also be pushed up one position. Remember that PC-DOS will support only four drives: A:, B:, C:, and D:.

CAUTION

Do not configure a SuperDrive disk unit in place of a real physical drive without using the /I option, or you will not be able to access the real physical drive until the system is rebooted.

2.3.2 Memory Allocation Parameters

- [/U=xxx] This option reserves a minimum of xxxK bytes of memory for the application program and its work space. This is the area of memory which your application program will run in. For example, if the instructions to your word processor program say that it needs 128K to run, you would use a value of "/U=128". If no /U=xxx parameter is specified, SuperDrive will reserve a minimum default program space of 64K. The SuperDrive program will not use this memory.

Note that the value specified by `/U = xxx` is only a minimum; there may be more available if you have not allocated all other memory to SuperDrive and/or SuperSpool. After creating your SuperDrives, you can verify how much user memory is available by using the CHKDSK function.

If you use the `/U = xxx` option, you must use the exact same `/U = xxx` parameter in all SuperDrive and SuperSpool command parameters. The value specified by the `/U = xxx` option has priority over all other memory allocation.

`/M = xxx`] This option reserves xxxK bytes of memory for SuperDrive use. Your application program does not use this memory.

If the `/M` option is omitted, as much memory as possible will be allocated to SuperDrive, up to the default storage size of the SuperDrive disk (the `/1` and `/2` options will influence the default storage size). With the `/M = xxx` option, you can specify exactly how much memory will be allocated to the selected SuperDrive. This can be used to apportion SuperDrive memory space and will allow you, for example, to create multiple SuperDrives of specific capacities.

When you wish to create a standard-sized single- or double-sided drive, it is not necessary to use the `/M = xxx` option since `/1` and `/2` automatically allocate the proper amount needed.

The actual amount of memory used up for the SuperDrive will be slightly more than the value specified by `/M = xxx`.

NOTE

The following options are for users who have their system board switches set for less memory than what is actually installed in the computer, or for users who have noncontiguous memory at hexadecimal address `:C0000` or higher.

[/DH] This option ("Disable High-Memory Use") prevents SuperDrive and SuperSpool from using any portion of contiguous memory which might be available above the limit set by the system board switches (only the PC-1 and PC-2 have high memory). It does not, however, prevent them from using any noncontiguous memory which may be present beginning at address :C0000 and up, or from using memory available below the switch settings. It has no effect if there is no contiguous memory available above the switch settings.

[/DL] This option ("Disable Low-Memory Use") prevents SuperDrive and SuperSpool from using any portion of user memory, that is, contiguous memory below the limit set by the system board switches. It restricts them to using only the memory available above the switch settings. If noncontiguous memory is available beginning at address :C0000, it is used first. This implies that there must be memory available above the switch settings in order to use this option.

[/DNC] This option ("Disable Noncontiguous Memory Use") prevents SuperDrive and SuperSpool from using any noncontiguous memory which may be available beginning at address :C0000 or higher. If contiguous memory is available above the limit set by the switch settings, it is used first.

[/DMMGMT] This option ("Disable Memory Management") disables calls to DOS memory management (DOS 1.1 does not have memory management). Normally the SuperDrive and SuperSpool programs will call DOS memory management in an attempt to acquire any additional, unused memory. Using */DMMGMT* prevents those programs from acquiring additional memory from DOS. You would use this option to ensure that SuperDrive or SuperSpool do not use any unallocated memory that you may want to subsequently allocate to other programs. DOS memory management does not allocate high or noncontiguous memory. Section 10 ("DOS Memory Management") of *IBM Personal Computer Disk Operating System Technical Reference Manual* (version 2.10) provides further information on the DOS memory management calls.

2.3.3 Number of Sectors Per Track

/8 Specifies eight sectors per track when running under DOS 2.x (for creating SuperDrives that are compatible with DOS 1.1 diskettes). If this parameter is omitted, a value of nine sectors per track will be used under DOS 2.x. When running under DOS 1.1, this parameter is unnecessary since DOS 1.1 supports eight sectors only.

2.4 SuperDrive Examples

The following examples are provided to demonstrate how to use the SUPERDRV command (for a step-by-step example of how to create and use SuperDrive, see Subsection 2.6).

These examples assume the user has two floppy drives (physical drives A: and B:), has set his system board switches for a total of four floppy drives (refer to Section 2.2), and has sufficient memory to successfully execute the commands without error (Subsection 2.7 discusses SuperDrive error messages).

SUPERDRV C:<Enter>

Allocates a minimum of 64K bytes of memory for application program (since we did not use the /U=xxx parameter, the default value of 64K is used). Since we did not specify a specific size drive, the default value is used; adds one double-sided SuperDrive as drive C:.

SUPERDRV C:/1 <Enter>

Allocates a minimum of 64K bytes of memory (by default) for application program. Adds one single-sided SuperDrive as drive C:.

SUPERDRV B: <Enter>
SUPERDRV C:/1 <Enter>

Allocates a minimum of 64K bytes of memory for application program. Adds one double-sided SuperDrive as drive B: which replaces physical drive B:. Physical drive B: is no longer accessible. Drive C: becomes a single-sided SuperDrive.

SUPERDRV A:/1/1 <Enter>

Allocates a minimum of 64K bytes of memory for application program. Inserts a single-sided SuperDrive as drive A:. Physical drive A: becomes drive B:. Physical drive B: becomes drive C:. This command cannot be used inside an AUTOEXEC file.

SUPERDRV C:/2/U = 128 <Enter>

Allocates a minimum of 128K bytes of memory as application program memory, and adds a double-sided SuperDrive as drive C:.

SUPERDRV B:/1/1/U = 128/M = 80 <Enter>
SUPERDRV D:/2/U = 128/M = 100 <Enter>

Allocates a minimum of 128K bytes for application program memory, then inserts an 80K-byte single-sided SuperDrive as drive B:. Physical drive B: becomes drive C:. Drive D: is added with 100K of capacity in double-sided format. Note that the same /U = xxx parameter must be used in each command.

The following examples use the /DH, /DL, /DNC and /DMMGMT parameters. These parameters are provided for use in systems in which there is more memory installed than what the system board switches are set for.

SUPERDRV C:/1/U = 256/M = 100/DH <Enter>

Allocates a minimum of 256K bytes for application program memory. Creates a SuperDrive as drive C:, which will be single-sided, 100K. Restricts SuperDrive from using any contiguous memory which may be available above the limit set by the switch settings.

SUPERDRV C:/2/U = 320/DL <Enter>

Allocates a minimum of 320K bytes for application program memory. Creates a SuperDrive as drive C:, double-sided. Prevents SuperDrive from using any part of contiguous memory below the setting of the system board switches.

SUPERDRV C:/1/M = 100/DL/DNC <Enter>

SUPERDRV D:/M = 50/DL/DNC <Enter>

Allocates a minimum of 64K bytes for application program memory. Creates a single-sided, 100K SuperDrive as drive C:. Creates a double-sided (by default), 50K SuperDrive as drive D:. Prevents SuperDrive from using any noncontiguous memory (if there is any available) and prevents it from using any contiguous memory available below the switch settings. This implies that there must be sufficient contiguous memory available above the switch settings (high memory) to successfully perform both of these commands.

SUPERDRV B:/1/U = 384/DH/DL <Enter>

SUPERDRV C:/1/U = 384/DH/DL <Enter>

SUPERDRV D:/1/U = 384/DL <Enter>

Allocates a minimum of 384K bytes of memory for application program. Creates a standard, single-sided SuperDrive as drive B:, located in noncontiguous memory; physical drive B: is no longer accessible. Creates a single-sided SuperDrive as drive C:, located in noncontiguous memory, whose size will be whatever is left over there from the previous command (around 30K when the maximum 192K was available). Creates

a standard, single-sided SuperDrive as drive D:. Since noncontiguous memory has been exhausted from the previous two commands, drive D: will be located in contiguous memory above the switch settings of the system board.

SUPERDRV B:/2/U = 256/DMMGMT

This command creates a two-sided SuperDrive B: (the disk size defaults to the standard DOS 2.0 and 2.1 360K disk size), reserves 256K for the application program, and disables calls to DOS memory management.

2.5 SuperDrive Application Notes

CAUTION

Since any data stored on a SuperDrive is actually stored in RAM, it will be lost if there is a power failure or whenever you turn the computer off or reboot the system. Only noncritical files should be stored on a SuperDrive disk drive. This protects you in the event of a power outage.

2.5.1 Using SuperDrive with Overlay Software

One of the most common and useful applications of SuperDrive uses the electronic disk to store multipart application programs which use "overlays".

For example, if your application software is menu-driven or option-oriented, it probably consists of several different programs, each corresponding to an option. When you choose an option, the appropriate program is loaded into RAM from disk. Word Processing programs are excellent examples of overlay software. Switching between options, menus, formats, or other logical program divisions can be a time consuming "wait for the disk drive" experience.

By copying such programs to a SuperDrive disk and executing them from SuperDrive, the transition time between the various options becomes virtually unnoticeable. We recommend that you store your data files directly to a floppy diskette in case of power failure. This gives you maximum speed while maintaining maximum data integrity.

2.5.2 Protecting Important Data Files

If you do elect to store data files on a SuperDrive, you may want to execute your application program from an AUTOEXEC.BAT file such as the one illustrated below. We suggest you add a command to the AUTOEXEC file immediately following the command to run your program, which will transfer (COPY) your data file(s) from the SuperDrive back over to a floppy. Thus, as long as you take an orderly exit from your program back to DOS, the Autoexec file will automatically take control and copy your data files to a floppy diskette.

For example, let's say your program and data files are all contained on drive A: and you want to run this program on a SuperDrive as drive C:, modify the data file also on drive C:, exit to DOS when finished, and have your data file copied back to floppy drive A:. The AUTOEXEC file on your DOS diskette in drive A: might look like this:

```
ASTCLOCK
SUPERDRV C:/1
COPY A:.* C: (copy all files from drive A: to drive C:)
C:
[name of application program to run from drive C:]
COPY C:.* A: (copy all files from drive C: to drive A:)
```

Now, when you exit your application program and return to DOS, everything on the SuperDrive disk (drive C: in our example) will automatically be copied to your floppy diskette in drive A:.

2.5.3 Creating SuperDrive A: from an AUTOEXEC File

PC-DOS will not let you create a SuperDrive as drive A: from an AUTOEXEC file. However, you can circumvent this problem; the following two batch files illustrate how to do this. Again, we are assuming you have two physical drives, A: and B:. A number of other commands have been included to illustrate what you can do with batch files. For convenience, we have included the exact keyboard commands to use when creating these two batch files.

```
COPY CON: AUTOEXEC.BAT <Enter> This file resides on the  
RAMCLEAR <Enter> diskette in drive A: (the  
ASTCLOCK <Enter> boot diskette) at the  
MODE LPT1: <Enter> time the system is booted.  
B: <Enter>  
MAKE-A <Enter>  
<F6> <Enter>
```

```
COPY CON: MAKE-A.BAT <Enter> This file resides on  
SUPERDRV A:/1/1 <Enter> the diskettes in both  
SUPERSPL LPT1: <Enter> drives A: and B: at the  
COPY B:*. * A: <Enter> time the system is booted.  
A: <Enter>  
[command to execute application program from A:] <Enter>  
<F6> <Enter>
```

This method requires that, at boot time, the diskette in drive A: contain all of the programs that you want to execute from the SuperDrive drive A:, and that both drives A: and B: contain the above file MAKE-A.BAT. The diskette in drive B: contains SuperDrive and SuperSpool.

2.5.4 Single Drive Systems

If you have only one physical drive but your system board switches are set for two or more drives for use with SuperDrive and you wish to use the DISKCOPY command to copy a floppy diskette, be sure to specify drive A: as both the source and target diskette (DISKCOPY A: A:). You can, of course, DISKCOPY to and from a SuperDrive if it is the same size as your physical drive A:.

If you want to use the COPY command to move files from one diskette to another, you will have to use the command in conjunction with SuperDrive. COPY the file(s) you want to transfer over from drive A: to the SuperDrive B:, insert the actual destination diskette in drive A:, and COPY back from drive B: to drive A:.

2.5.5 Using DOS Commands With SuperDrive

When you create a SuperDrive, you should think of it as a formatted data disk, with no DOS installed on it. The process of creating the SuperDrive automatically FORMATS it for you, so you do not need to execute a FORMAT as a separate operation. In fact, if you attempt to FORMAT a nonstandard size SuperDrive when using DOS 1.1, you will get errors (due to a bug in FORMAT), so it is best not to use the FORMAT command at all.

All other DOS commands will function on a SuperDrive just as they do on a real floppy drive. However, you can use the DISKCOPY command only if your floppy diskette and your SuperDrive are identical in size. If you have single-sided drives, you will not be able to use the DISKCOPY command to copy double-sided diskettes. You can use double-sided drives to DISKCOPY single-sided diskettes.

You can perform simple DOS commands in between creation of multiple SuperDrives. For example, you can use the following command sequence:

```
SUPERDRV A:/I  
COPY B:.* A:  
SUPERDRV B:/I  
COPY D:.* B:
```

You cannot execute application programs in between creation of multiple SuperDrives.

2.5.6 SuperDrive Compatibility

As a general rule, if the program you want to use with SuperDrive will allow itself to be copied to a floppy drive, it can also be copied to and executed from a SuperDrive. If, on the other hand, your program is currently stored on a copy-protected diskette, you will probably not be able to use it with SuperDrive.

If your program is currently executed from an AUTOEXEC file on a boot diskette, and you want to modify it to run with SuperDrive, you will have to modify the Autoexec file. To determine what is currently in that Autoexec file, at DOS prompt `A>` insert the boot diskette to be modified in drive A: and enter

```
TYPE AUTOEXEC.BAT <Enter>
```

What you need to do is to create a new Autoexec file with the appropriate SuperDrive and/or SuperSpool command(s) preceding the commands(s) listed as a result of the above TYPE command.

```
COPY CON: AUTOEXEC.BAT <Enter>  
SuperDrive commands  
other commands  
.  
.  
.  
<F6> <Enter>
```

Some programs insist upon accessing a specific drive even though the default drive has been changed to something else. If this is the case for your program, you will have to configure your SuperDrive(s) to be the same designation as that which the program expects.

2.6 SuperDrive Example

This subsection takes you step-by-step through the process of creating and using a SuperDrive. We assume that you have two double-sided floppy drives and that you want to create a double-sided SuperDrive as drive C:. You should have previously set up the system board switches for at least three drives, as outlined in Section 2.2.

Step 1

Create the SuperDrive by entering a command such as the following:

```
SUPERDRV C:<Enter>
```

SuperDrive responds on the screen with a message such as:

```
S u p e r D r i v e      V e r s i o n  x . x  
©Copyright AST Research, Inc.  1983, 1984
```

```
resident portion loaded
```

```
Drive C: configured at &Hxxxxx with  
xxxxxx bytes
```

```
A>
```

This tells us that the SuperDrive was successfully created. *&Hxxxxx* is the hexadecimal starting memory address of SuperDrive (for information only), and *xxxxxx bytes* is the capacity of the SuperDrive. If you received some kind of error message, refer to Subsection 2.7.

Step 2

COPY all of the files from drive A: to drive C:. Here we assume that the diskette in drive A: contains all of the programs and data files that you want to copy to the SuperDrive.

```
COPY A:*. * C:<Enter> (to copy file by file)
```

or

```
DISKCOPY A: C:<Enter> (if both drives are the same size)
```

Step 3

Change the default drive from drive A: to drive C:.

C: <Enter>

Step 4

Execute the program you want to run from the SuperDrive.

name of program <Enter>

That's all there is to it. Now you can treat the SuperDrive just like a floppy drive.

2.7 Error Messages

SuperDrive may give you an error message under certain conditions. These messages are described below.

INVALID DRIVE SPECIFICATION . . . ABORTING

This message indicates that either the system board switches have not been set for the correct number of drives (Section 2.2) or you have used an invalid drive letter in your SuperDrive command.

INSUFFICIENT MEMORY . . . ABORTING

This message indicates that there is insufficient, unallocated memory available in the system to create a SuperDrive of any size.

SHORT xxxxxx BYTES

This is not really an error message. It indicates that the SuperDrive you have just created is something less than a standard sized drive in size. This could happen if you use the /M=xxx option to create a nonstandard drive, or if there were some memory available, but not quite enough to make the drive exactly the size you specified.

(This page intentionally left blank)

SECTION 3

SUPERSPOOL

SuperSpool™ © Copyright 1983 AST Research, Inc.

This software has been provided pursuant to a License Agreement containing restrictions on its use. The software contains proprietary information of AST Research, Inc., and is protected by federal copyright law. It may not be copied and distributed in any form or medium without prior written permission from AST Research, Inc.

NOTE

The information contained in this section applies to SuperPak version 4.1 (or subsequent) and SuperSpool 1.30 (or subsequent). SuperSpool 1.30 (or later) is *not* compatible with the pre-1.30 SuperDrive program.

3.1 Introduction

The SuperSpool program provides buffered output of print data to a parallel or serial printer and allows you to run other programs *at the same time*. Files to be printed will be output to the SuperSpool buffers at the maximum I/O speed allowed by PC-DOS, while the SuperSpool program handles output to the printer at printer speed. SuperSpool operates in the "background" and frees the operating system for other tasks, such as executing another program.

A simple example of one of the things you can do with SuperSpool is to print a listing of a BASIC program while running that same program on your PC. In effect, the BASIC program code is dumped into the print buffer, which then releases control of the program to the operating system.

SuperSpool includes these features:

- Provides buffered output of print data to either a parallel or serial printer
- Has a simple command sequence that allows you to specify printer ports as well as serial output baud rates and line conditions
- Allows you to define the size of the spool buffer and control its location in memory
- Allows stop/restart, previous page, and line-per-page controls to be invoked from the keyboard
- SuperSpool's "straight wire" spool buffer does not modify print file data
- Compatible with IBM PC-DOS and SuperDrive
- Compatible with IBM PC-1, PC-2, PC-XT, and Portable PC

3.2 Preparing PC-DOS for SuperSpool

Before you enter your SuperSpool command, you must enter the DOS MODE command (MODE.COM program comes with PC-DOS, and should be on your working DOS diskette):

```
MODE LPT1:<Enter>
```

The DOS response is:

```
LPT1: not redirected
```

This response is normal and not an indication of an error. The MODE LPT1: command should be used even if you are using a serial printer. You only need to enter the MODE LPT1: command once at the start of each computing session.

3.3 The SUPERSPL Command

Because SuperSpool is a program, it must be initialized each time you turn on your PC. This section describes in detail the various commands and options you can use and the format in which they must be entered. Section 3.8 gives a step-by-step example of the actual process for creating a SuperSpool print buffer.

The SuperSpool initialization command you use depends on the type of printer (serial or parallel) you are outputting to:

For output to a parallel printer port (LPTn):

```
SUPERSPL LPTn:[/U = xxx][/M = xxx or /M]
  [/DH][/DL][/DNC][/DBI]
[/DMMGMT][/LPP = xx][/B][/S][/C][/R][/RP][/P] <Enter>
```

For output to a serial printer using a serial port (COMn):

```
SUPERSPL LPTn: = COMn:[/RATE = xxx[,parity[,databits[,stopbits]]]
[/ON = option][/OFF = option][/U = xxx][/M = xxx]
[/DH][/DL][/DNC][/DBI][/DMMGMT][/LPP = xx][/B][/S][/C][/R]
[/RP][/P] <Enter>
```

Note that each optional parameter is preceded by a slash (/). Do not use a space or commas to separate options.

3.3.1 Specifying the Output Port

The IBM PC normally sends all printer output to LPT1 unless you redirect the output to a different port. When either a serial or parallel port is assigned for printer output with SuperSpool, that port cannot be used by any other program for any purpose until you use another SuperSpool redirection command (Topic 3.5.4) to “release” the port.

For a parallel printer:

LPTn: Selects one of the three possible parallel ports: LPT1, LPT2, or LPT3. Note that your version of PC-DOS may not allow normal parallel output to any port other than LPT1.

For a serial printer:

LPTn = COMn: Redirects parallel printer output to a serial port. COM1 and COM2 are the only valid serial ports. LPTn now responds as LPTn + 1 (LPT1 becomes LPT2, etc). This format of the SuperSpool command replaces the DOS MODE command for redirecting output from the parallel port LPT1 to serial port COM1 or COM2.

3.3.2 Serial Printer Configuration Parameters

When using SuperSpool with a serial printer, these SuperSpool parameters replace the equivalent MODE command for baud rate, parity, data bits, and stop bits:

[/RATE = xxxx] For serial printers only. Sets the baud rate of the selected serial communication adapter (110, 150, 300, 600, 1200, 2400, 4800, or 9600 baud).

[/parity] For serial printers only. Parity is either N (None), O (Odd), or E (Even). Default is Even.

[/databits] For serial printers only. Either 7 or 8. Default is 7.

[/stopbits] For serial printers only. Either 1 or 2. If */RATE = 110*, use 2; otherwise use 1 (these are also the default values).

[/ON = option,...] [/OFF = option,...] For serial printers only. This parameter is used to turn on and off certain serial printer port line protocol options. Output to a serial printer occurs only when all SuperSpool printer output conditions have been met. This applies to XON/XOFF, DCD, DSR, and CTS.

Data set line conditions are determined by the state of the signals DCD, DSR, and CTS. You can make SuperSpool ignore all data set line conditions with this command:

`/OFF = DCD,DSR,CTS,XON`

You can enable any or all of these lines with a similar `"/ON = option(s)"` command. Whether you use the `/ON` and `/OFF` options depends on the internal configuration of your serial printer and its cabling to the PC. `XON/XOFF` is enabled by `"/ON = XON"` and disabled by `"/OFF = XON"`.

The default condition of the data set line conditions is CTS and DSR ON; that is, SuperSpool must see them ON before it will output data to the printer. DCD and XON/XOFF are OFF (ignored).

Consult your printer manual for information on its particular requirements in all the above serial options. Also check the AST Research product user's manual for further information.

3.3.3 Memory Allocation Parameters

`[/U = xxx]` This option prevents SuperSpool from using ALL memory for a print buffer by reserving a minimum of xxxK bytes of memory for the application program and its work space. If you do not use the `/U = xxx` option, SuperSpool reserves a minimum default application program space of 64K. SuperSpool will not interfere with this memory (see Topic 2.3.2 for a more detailed discussion of this parameter).

If you use the `/U = xxx` parameter with the `SUPERSPL` command, you must use the exact same parameter in your `SUPERDRV` commands.

`[/M = xxx]` This option allocates xxxK bytes of memory to SuperSpool for use as a print buffer. If you do not use the `/M = xxx` option, the buffer size defaults to 64K. Using spool buffers of less than 4K bytes is not recommended for efficient operation. If you use this option, do not use the `/M` option.

[/M] This is similar to the */M = xxx* option, except that ALL remaining available memory which has not been reserved for application program space (*/U*) or for SuperDrive(s) or for DOS itself will be allocated to the spool buffer. This is a powerful option in that it allows for absolutely no wasted memory space after making the other necessary memory allocations. If you use this option, do not use the */M = xxx* option. Note that a SUPERSPL command using the */M* parameter probably will not leave enough memory for other driver-type programs to load successfully. Therefore, the other drivers should be loaded before SuperDrive and SuperSpool.

NOTE

The following options are for users who have their system board switches set for less memory than what is actually installed in the computer, or for users who have noncontiguous memory at hexadecimal address :C0000 or higher.

[/DH] This option ("Disable High-Memory Use") prevents SuperDrive and SuperSpool from using any portion of user memory, that is, contiguous memory which might be available above the limit set by the system board switches. It does not, however, prevent them from using any noncontiguous memory which may be present beginning at address :C0000 and up, or from using memory available below the switch settings. It has no effect if there is no contiguous memory available above the switch settings.

[/DL] This option ("Disable Low-Memory Use") prevents SuperDrive and SuperSpool from using any portion of contiguous memory below the limit set by the system board switches. It restricts them to memory available above the switch settings. If noncontiguous memory is available beginning at address :C0000, it is used first. This implies that there must be memory available above the switch settings in order to use this option.

[/DNC] This option ("Disable Noncontiguous Memory Use") prevents SuperDrive and SuperSpool from using any noncontiguous memory which may be available beginning at address :C0000. If contiguous memory is available above the limit set by the switch settings, it is used first.

[/DMMGMT] This option ("Disable Memory Management") disables calls to DOS memory management (DOS 1.1 does not have memory management). Normally the SuperDrive and SuperSpool programs will call DOS memory management in an attempt to acquire any additional, unused memory. Using **/DMMGMT** prevents those programs from acquiring additional memory from DOS. You would use this option to ensure that SuperDrive or SuperSpool do not use any unallocated memory that you may want to subsequently allocate to other programs. DOS memory management does not allocate high or noncontiguous memory. Section 10 ("DOS Memory Management") of *IBM Personal ComputerDisk Operating System Technical Reference Manual* (version 2.10) provides further information on the DOS memory management calls.

[/DBI] Disable Block Transfer Interface. This SuperSpool option disables the block transfer interface that allows easier interface between SuperSpool and other application software. You can disable this interface to avoid a conflict if your application software uses interrupt vector INT 58H.

3.3.4 Printer Format and Secondary Options

[/LPP=xx] Sets the number of lines per page. Default is 66. Please note that SuperSpool does not automatically page your documents for you. The LPP option is used in conjunction with formfeed characters sent to the printer by your software to control paging.

/B) This option enables the */RP* and */R* options (which are explained below). We recommend that you specify the */B* option only when the spool buffer is at least 16K bytes in size. Additional buffer space is used to "save" the extra page or two of print data and, in smaller buffer configurations, could consume all available spool buffer space.

NOTE

The */B* option is designed for use with text that contains the form feed and line feed characters at the appropriate intervals, and does not operate correctly if the form feed and line feed characters are not output to the printer.

Do not combine the */B* option with the */R* or */RP* options in the same line. The */B* option is to be used when first initializing your spool buffer. The */R* and */RP* options are for use only after printing has already begun.

The following secondary commands can be invoked from DOS while spooling is taking place to control the printer and the spool buffer output. If your printer has its own internal input buffer, some of the commands may take some time to take effect as the printer empties its own internal buffer.

/S) Stop output of print data. No data will be lost, and you can restart data transmission at any time by using the *SUPERSPL/C* command.

/C) Continue output of print data, if previously stopped by the *SUPERSPL/S* command.

/R) The printer output will be restarted at the beginning of the current page, if enabled by a *SUPERSPL/B* command.

[/RP] The printer output will be restarted at the beginning of the previous page, if enabled by the SUPERSPL/B command.

[/P] Immediately purge (empty) all data from the SuperSpool print buffer.

Subsection 3.5 gives examples of how to use the above options.

3.4 SuperSpool Examples

The following examples illustrate how to use the SUPERSPL command. AST Research recommends that you review and understand these commands before you try to use SuperSpool for the first time. Section 3.8 has a step-by-step example of how to create a spool buffer. Section 2.3.2 discusses the use of the /DH, /DL, and /DNC options which may appear in some examples.

3.4.1 SuperSpool Parallel Printer Examples

SUPERSPL LPT1: <Enter>

Spools printer output to LPT1. No /U = xxx option was used, so reserves by default a minimum of 64K for the application program. No /M or /M = xxx option was used, so reserves by default 64K for use as the spool buffer.

SUPERSPL LPT1:/M = 16/LPP = 60/B/DMMGMT <Enter>

Spools printer output to LPT1. No /U = xxx option was used, so reserves by default a minimum of 64K for the application program. Reserves 16K for use as the spool buffer. Sets the number of lines per page to 60. Enables subsequent use of the /R and /RP commands. Disables memory management calls.

SUPERSPL LPT1:/U = 192/M/DBI <Enter>

Spools printer output to LPT1. Reserves a minimum of 192K for the application program. Uses all remaining memory (except for what DOS uses) for the spool buffer. Disables the block transfer interface (to avoid a conflict if your application software used interrupt vector INT 58H).

3.4.2 SuperSpool Serial Printer Examples

In each of the following serial printer examples, the LPTn port being redirected to COMn becomes LPTn + 1 after activating SuperSpool (LPT1 responds as LPT2; LPT2 becomes LPT3). The SuperSpool command replaces the equivalent DOS MODE commands for serial printers.

SUPERSPL LPT1: = COM1:/RATE = 1200,N,8,1/B/DBI <Enter>

Spools printer output to serial port COM1 (redirected from LPT1) at 1200 baud, no parity, 8 data bits, 1 stop bit. No /U = xxx option was used, so reserves by default a minimum of 64K for the application program. No /M or /M = xxx option was used, so reserves by default 64K for the spool buffer. Enables subsequent use of the /R and /RP commands. Disables block transfer interface (you would use the /DBI option to avoid a conflict if your application software used interrupt vector INT 58H).

SUPERSPL

LPT1: = COM2:/RATE = 110,E,7,2/U = 128/M = 16 <Enter>

Spools printer output to serial port COM2 (redirected from LPT1) at 110 baud, even parity, 7 data bits, 2 stop bits. Reserves a minimum of 128K for the application program. Reserves 16K for use as the spool buffer.

SUPERSPL

**LPT1: = COM1:/RATE = 2400,E,7,1/ON = CTS/OFF = DCD,
DS/M = 100/B/DMMGMT <Enter>**

Spools printer output to serial port COM1 (redirected from LPT1) at 2400 baud, even parity, 7 data bits, 1 stop bit. Monitors the CTS input from the printer to determine when data can be sent to it, and ignores the DCD and DSR inputs. No /U = xxx option was used, so reserves by default a minimum of 64K for the application program. Reserves 100K for use as the spool buffer. Enables subsequent use of the /R and /RP commands. Disables all memory management calls.

SUPERSPL

**LPT1: = COM1:/RATE = 300,N,8,1/ON = XON/OFF = DCD,
DSR,CTS/U = 320/M <Enter>**

Spools printer output to serial port COM1 (redirected from LPT1) at 300 baud, no parity, 8 data bits, 1 stop bit. Monitors the XON code from the printer to determine when data can be sent to it, and ignores the DCD, DSR, and CTS lines. Reserves a minimum of 320K for the application program. Uses all remaining memory except for what DOS needs for the spool buffer.

3.5 SuperSpool Secondary Commands

This section outlines the use of the various SuperSpool secondary commands. Secondary commands can be issued from DOS while a document is being printed to query the spool status, stop the printout, etc.

3.5.1 Page Reprint Options

If the */B* option has been previously selected, SuperSpool will monitor the printer output data stream for form feed (go to the top of the next page) and line feed (go to the next line) characters. A form feed character determines the top of page, while a line feed character specifies the end of a line and can also be used, by counting the number of line feeds per page, to determine the top of page.

The */R* or */RP* options tell SuperSpool to immediately continue output at the beginning of the specified page. You can use these options to restart your output at a convenient reference point (the top of the current or previous page) should the printer jam or otherwise malfunction. These purpose of these options is *not* to print multiple copies of the same document. You cannot use the */R* and */RP* options unless at least one page has been printed.

We recommend that you use the */R* and */RP* options in this sequence:

1. From DOS, enter this command to stop printer output:

SUPERSPL /S

2. Adjust the printer paper to place the paper at the top-of-form position, etc. If the printer has a control to set the top-of-form ("TOF Set" or equivalent), use it.
3. Enter

SUPERSPL /R or SUPERSPL /RP

to restart printing at the current or previous page, respectively.

3.5.2 Determining SuperSpool Status

Once you have activated SuperSpool, you can check its status at any time by entering the appropriate SUPERSPL command. The current printer configuration and spool buffer status (number of bytes remaining to be printed) will be displayed for reference at the completion of any "SUPERSPL [parameter]" command operation. While spooling is taking place, simply enter "SUPERSPL" from DOS to check its status.

3.5.3 Changing Printer Configuration

You can change the SuperSpool-directed printer port configuration when the spool buffer is empty. However, you can only modify the memory and buffer configuration options (/M or /M = xxx, /U = xxx) after rebooting the computer.

3.5.4 Secondary SuperSpool Examples

You can issue secondary SuperSpool commands after SuperSpool has already been brought up and is in use. Note that these commands do not deal with the size of the spool buffer or the configuration of the serial port's parameters.

SUPERSPL LPT1: = COM2:/B <Enter>

Redirects LPT1 to serial port COM2 using all previously defined SuperSpool options and the previously defined parameters for COM1. Spool buffer must be empty when redirecting ports. Also, enables /B option for page reprint functions.

SUPERSPL /LPP = 66/S <Enter>

Stops the printing, and sets lines per page equal to 66.

SUPERSPL /RP <Enter>

Restarts printing beginning at the previous page.

SUPERSPL LPT1:<Enter> (after prior redirection to serial port)

Terminates redirection to the serial port, and directs the spooler output to parallel printer LPT1. Spool buffer must be empty when redirecting ports. LPT2 reverts back to being LPT1, etc.

SUPERSPL /B <Enter>

Enables the /R and /RP print options.

SUPERSPL <Enter>

Displays SuperSpool status.

3.6 SuperSpool Compatibility

The SuperSpool program is designed to be transparent to PC data files. The output of data files is done via the LPTn parallel ports or via the COMn serial ports (after invoking the SuperSpool redirect command).

If you use word processing programs that have custom printer selections, you can use only their parallel printer option if you want to use SuperSpool for output. Most of these word processing programs have special serial port driver routines which may not be compatible with the SuperSpool program. This may also be true of any other application software which allows you to customize its serial printer output parameters. THIS INCOMPATIBILITY IS NOT CAUSED BY A PROBLEM WITH SUPERSPOOL!

The SuperSpool software was designed to determine its own output parameters and is simply not meant to contend for output resources with another program. Consult with the supplier of your other software for advice on how to disable its custom serial port driver routines.

Certain programs, especially word processors, will not instantaneously send a large document out to a printer. These programs modify the print data "on the fly", which takes time. They will probably run faster with SuperSpool than without it, but not as fast as, for example, LLISTing a BASIC program through SuperSpool.

Once the SuperSpool program has started, you can output data or files using DOS COPY commands or BASIC and BASICA PRINT commands via the parallel port. The screen print function will also work.

Always use the SuperSpool redirect commands if you want to spool to a COMn serial port. Do not use the DOS MODE command as a shortcut to redirect printer output; doing so will short circuit the SuperSpool software.

3.7 SuperSpool Utility Batch Files

You can invoke the SuperSpool program from an AUTOEXEC.BAT file just like ASTCLOCK and SUPERDRV. The only real restriction is that the SUPERSPL command must immediately follow those for SuperDrive, and a "MODE LPT1:" command should be invoked before everything else (necessary only once per session). Refer to the "Batch Processing" section of your IBM DOS manual for more detailed information on batch files.

You may want to add one or more batch files to your working DOS diskette to allow you to invoke the printer control options or display SuperSpool status automatically when you type in a short command while under DOS. This eliminates the lengthy commands you would have to use otherwise.

The commands in this example create a batch file that spools print data to a typical NEC serial printer at 1200 baud, even parity, seven data bits, one stop bit, monitor the CTS signal, ignore the DCD and DSR signals, set up a 16K print spool buffer, and select page reprint functions. It also allocates a minimum of 64K bytes for your application program. This example includes the exact keyboard sequences for creating the batch files.

```
COPY CON: NEC.BAT <Enter>  
MODE LPT1:  
SUPERSPL LPT1:= COM1:/RATE = 1200,E,7,1  
  /ON = CTS/OFF = DCD,DSR/M = 16/B <Enter>  
<F6> <Enter>
```

Once the above file is on your DOS diskette, all you have to do to initialize SuperSpool for this NEC printer is type in:

```
NEC <Enter>
```

3.8 SuperSpool Example

The example in this subsection shows the step-by-step procedure to use to bring up SuperSpool. This example assumes that the diskette in drive A: contains MODE.COM and SUPERSPL.COM and that there is sufficient memory in the system to successfully execute the SuperSpool commands.

Step 1

Prepare DOS for SuperSpool by using the MODE command:

```
A>MODE LPT1:<Enter>
```

The DOS response is:

Resident portion of MODE loaded

LPT1: not redirected.

Step 2

Issue the SuperSpool command for your printer. This example illustrates a command for a parallel printer.

```
A>SUPERSPL LPT1:<Enter>
```

The screen then displays:

```
SuperSpool      Version x.xx  
©Copyright AST Research, Inc.  
1983, 1984
```

```
resident portion loaded
```

```
65536 bytes allocated for  
SuperSpool buffer
```

```
LPT1: is ready  
0 bytes buffered for output
```

SuperSpool has informed us that it has loaded itself into memory and has reserved 65536 bytes (64K) for the spool buffer. Spooling will be done to LPT1 and the buffer currently contains 0 bytes of data (because we have not printed anything yet). By default, SuperSpool has also reserved a minimum of 64K for the application program. If a command had been given for a serial printer instead of a parallel printer, SuperSpool would also inform us that LPT1 is being redirected to COM1 or COM2 and would tell us which of the signals DCD, DSR, CTS, and XON/XOFF are being monitored ("required ON for output").

Step 3

To test the spooler, give a Print Screen command (<Shift>-<PrtSc>). The cursor should "fly" down the screen as data is sent to the spool buffer, while SuperSpool outputs the data from the spool buffer to the printer at whatever rate the printer will accept it.

Now you can run whatever program you want and let SuperSpool handle output of data to the printer for you.

SECTION 4

SUPERDRIVE AND SUPERSPOOL: RULES FOR USE

The powerful SuperDrive and SuperSpool utility programs can greatly enhance your PC's capabilities. This section gives you the rules you need to understand to use SuperSpool and SuperDrive successfully.

You *must* follow these rules to use SuperDrive and SuperSpool:

1. You must set switches inside the computer for the total number of drives, including SuperDrive (just as if it were a floppy drive). For example, if you have two floppy drives and want SuperDrive to be drive C:, set the switches for three drives.

Section 2 of this manual tells you how to set the PC's switches and Appendix B tells you how to patch your DOS diskettes.

2. When using both SuperDrive and SuperSpool, if the /U = xxx option is used with either program, the exact same /U = xxx option must be used with both programs.
3. When using both SuperDrive and SuperSpool, the SuperDrive commands must immediately precede the SuperSpool commands. Both programs should be initialized before you run your application software.
4. If you want to reconfigure the /U = xxx, /M, or /M = xxx parameters for either SuperDrive or SuperSpool, you must reboot the computer and start from scratch.

5. DOS will not let you create a drive A: SuperDrive as part of an AUTOEXEC.BAT file. Topic 2.5.3 tells you how to circumvent that restriction.
6. When you use SuperDrive with the IBM fixed disk, you cannot replace the fixed disk with a SuperDrive, and you cannot displace it to a higher letter designation with the /I option.

Both SuperSpool and SuperDrive function properly with DOS, BASIC, and BASICA. There may be programs that will not work properly with a disk emulator or print spooler. For example, when you use SuperSpool with a serial printer and a program (such as a word processor) that has its own serial printer driver routine built-in, there may be conflicts between the programs that prevent proper operation.

Another example of incompatible programs are applications programs which expect to be loaded and executed out of a specific memory range may not allow themselves to be displaced to a different address by SuperDrive and SuperSpool. SuperDrive and SuperSpool will function properly only with IBM's PC-DOS. They may not work with any other operating system.

MEMORY ALLOCATION

To make the most efficient use of all available memory, you should plan how to allocate this memory. To allocate memory properly, you must understand how SuperDrive and SuperSpool allocate memory for their own use and how this affects your user programs.

Throughout this section, we refer to contiguous and noncontiguous areas of memory. Because of changes IBM has made to the ROM BIOS, the PC-2 (the updated IBM PC with a 256K system board) and PC-XT do not support noncontiguous memory, nor will a PC-1 (the original IBM PC with a 64K system board) with a new ROM BIOS for the IBM hard disk (however, the PC-1 with an original ROM chip installed can support noncontiguous memory). Appendix A defines contiguous and noncontiguous memory. In the PC-XT, there is no "Switch #2" and there is no such thing as high memory because the computer automatically sees all installed memory, independent of any switch settings.

SuperDrive and SuperSpool follow a definite set of rules to apportion memory.

RULE 1: When the amount of memory in the PC is the same as the limit set by the system board switches, SuperDrive and SuperSpool put themselves into low memory, just above DOS, and displace the user's area upward toward the end of memory.

RULE 2: When there is more contiguous memory in the PC than the limit set by the system board switches, SuperDrive and SuperSpool will use the memory above the switch settings first, starting at the high end and working downward. When this memory is exhausted, SuperDrive and SuperSpool will begin using low memory, just above DOS, and displace the user's area upward.

RULE 3: When there is noncontiguous memory available beginning at address :C0000, as well as contiguous memory available above the limit set by the system board switches, the noncontiguous memory is used first, starting at the high end and working downward. When this is exhausted, the contiguous memory above the switch limit is used next (again, from high to low). Finally, when this is exhausted, low memory is used and the user's program area is displaced upward.

RULE 4: If any portion of SuperDrive or SuperSpool ends up in contiguous memory, so will the resident portion.

The following formula can help you to decide how to allocate your memory.

	xxxK	Total actual memory installed
Minus	- 032K	Approximate DOS requirement (16K for DOS 1.1)
Minus	- yyyK	Memory required by user program
Equals	= uuuK	Memory available to SuperDrive and SuperSpool (approximate)

5.1 Memory Allocation Examples

The diagrams that accompany the following examples are intended for illustration purposes only; the relative memory area sizes are not necessarily depicted to scale. These examples assume that you are using PC-DOS 2.1.

EXAMPLE 1

Your total system memory is 320K, which is what your system board switches are set for. You have two double-sided floppies. Suppose you want to run a program which uses 30K of memory for execution and requires 100K for storing data. 100K plus 30K equals 130K, which must be reserved for this program via the /U=xxx parameter in both SuperDrive and Superspool.

PC-DOS 2.1 needs about 32K for its use, so plugging the numbers into the equation, we get:

320K Total actual memory installed
Minus - 032K Approximate DOS memory requirement
Minus - 130K Memory required by user program
Equals = 158K Memory available to SuperDrive and
SuperSpool (approximate)

Note that you do not have enough memory to make SuperDrive a full, double-sided drive. Let's say you decide to allocate 80K to SuperDrive and that it will be drive C:. Whatever memory is left after this is to be allocated to SuperSpool. The following commands will do this for you:

```
SUPERDRV C:/U = 130/M = 80 <Enter>  
SUPERSPL LPT1:/U = 130/M <Enter>
```

These commands will work in this priority:

1. Reserve a minimum of 130K memory for your application software and protect it from use by SuperDrive and SuperSpool.
2. Allocate 80K to SuperDrive. Since we have not specified otherwise, it will attempt to create a double-sided drive which, of course, will be short 280K (360K minus 80K). The resident and buffer portions of SuperDrive will load above DOS and push the 130K user memory up above them.
3. Spool output to the parallel printer port LPT1, with /M causing SuperSpool to create a buffer whose size will be whatever amount of memory is left after the previous allocations. The resident and buffer portions of SuperSpool will locate themselves immediately above SuperDrive's area; the 130K user memory is pushed up above them to utilize the last 130K in the system.

The following diagram illustrates memory allocation in Example 1.

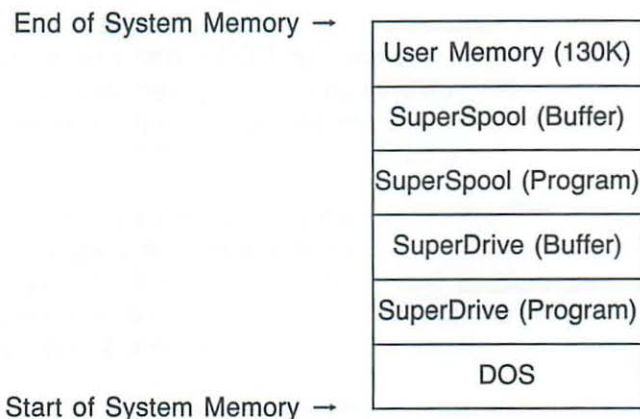

EXAMPLE 2

You have 320K installed in your system, which is what your system switches are set for. You have two single-sided floppies. Your program needs 64K reserved for its use, and you want to create a standard, single-sided SuperDrive (180K) inserted as drive B:.

320K Total actual memory installed
Minus - 032K Approximate DOS memory requirement
Minus - 064K Memory required by user program
Equals = 224K Memory available to SuperDrive and
SuperSpool (approximate)

You can use these commands:

```
SUPERDRV B:/I/ <Enter>  
SUPERSPL LPT1:=COM1:/RATE=1200,N,8,1/M <Enter>
```

These commands will work in this priority:

1. Reserve 64K of memory for user program space (since no size was actually specified with a /U = xxx option, the default value of 64K is used).

2. Make SuperDrive a standard, single-sided drive as drive B:. Note that you do not need to use the /M=180 option since /1 automatically allocates the 180K required for a single-sided drive. What was physical drive B: is now drive C: (via /I). SuperDrive and its buffer reside above DOS; the 64K user area has been displaced upward to the area above SuperDrive.

3. SuperSpool uses whatever memory is remaining (via its /M option) for spooling printer output to the serial port COM1. COM1 is set up for 1200 baud, no parity, 8 data bits, 1 stop bit. 64K (the default value) is reserved for the user program. SuperSpool and its buffer reside above SuperDrive, and the 64K user area has again been displaced upward, this time to the end of memory.

The following diagram illustrates memory allocation in Example 2.

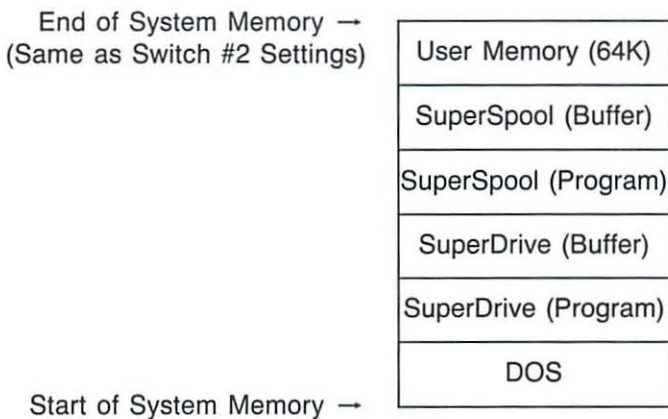

EXAMPLE 3

You have a total of 576K of memory installed, with your system board switches set for 544K. You have two double-sided floppies. You don't need SuperDrive this time, but you would like to use SuperSpool, and you want it to reside entirely in the memory above the switch settings so the full 544K will be available to your user program.

In this situation, the equation used in examples 1 and 2 no longer applies. Since there is 32K of memory above the switch settings, this is where the SuperDrive and/or SuperSpool programs will go first in allocating memory for their use. Through careful use of the /M = xxx option, we can restrict the programs to reside entirely in that high memory.

```
SUPERSPL LPT1:/M=29<Enter>
```

The above command will put both the resident portion of SuperSpool and a 29K spool buffer into high memory. Why 29K? Because you must allow room for the SuperSpool program itself (we allowed 3K in this example). We don't need /U = xxx this time since we are restricting the size and, therefore, the location of SuperSpool and its buffer.

A better, more efficient way to accomplish this would be:

```
SUPERSPL LPT1:/M/DL<Enter>
```

SuperSpool would use every available byte of memory above the limit of the switch settings and would be prevented from using any low memory by the /DL option.

Note that you could force both SuperDrive and SuperSpool to reside entirely above the limit of the system board switch settings. You could begin by using the /M = xxx and /DL options with SuperDrive, then use /M and /DL with SuperSpool. One way to verify that you have not inadvertently started using low memory is to use the CHKDSK function before and after the SuperDrive and/or SuperSpool commands. If the memory parameters (bytes free) are not identical before and after installing your SuperDrive and/or SuperSpool buffers, you have used up some of the low memory.

The following diagram illustrates memory allocation in Example 3.

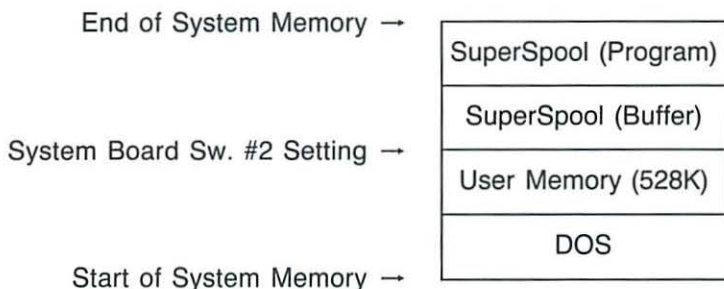

EXAMPLE 4

You have 640K total memory, and your system board switches are set at 512K. You have two double-sided floppies. You want to create two double-sided SuperDrives as drives C: and D:, and you need to reserve 128K for your application program. Whatever is left is to be used as a spooling buffer. The equation looks like this:

$$\begin{aligned} & 640\text{K Total actual memory installed} \\ \text{Minus} & - 32\text{K Approximate DOS memory requirement} \\ \text{Minus} & - 128\text{K Memory required by user program} \\ \text{Equals} & = 480\text{K Memory available to SuperDrive and} \\ & \quad \text{SuperSpool (approximate)} \end{aligned}$$

Since there is insufficient memory to create two double-sided SuperDrives, we will create one full-sized drive and one smaller drive.

```
SUPERDRV C:/U = 128 <Enter>
SUPERDRV D:/U = 128/M = 50 <Enter>
SUPERSPL LPT1:/U = 128/M <Enter>
```

These commands will work in this priority:

1. Reserve 128K of memory (always in low memory) for your application program.

2. Create a double-sided SuperDrive as drive C:. The resident (program) portion will be in low memory. The 360K drive will be created first out of whatever is remaining in high memory, and then start using low memory, pushing up the user memory area.
3. Create a double-sided, 50K SuperDrive as drive D:. Since the SuperDrive program code is already in memory, all that need be done is to create the buffer portion, which will locate immediately above the drive C: buffer. This again pushes up the 128K user memory area.
4. The size of the SuperSpool buffer (for LPT1) will be whatever memory space is left (via /M option). The resident portion of SuperSpool will be located immediately above the drive D: buffer; the spool buffer will be above the resident portion of SuperSpool; and the user memory is pushed up above everything else, to the end of memory as indicated by the switch settings.

The following diagram illustrates memory allocation in Example 4.

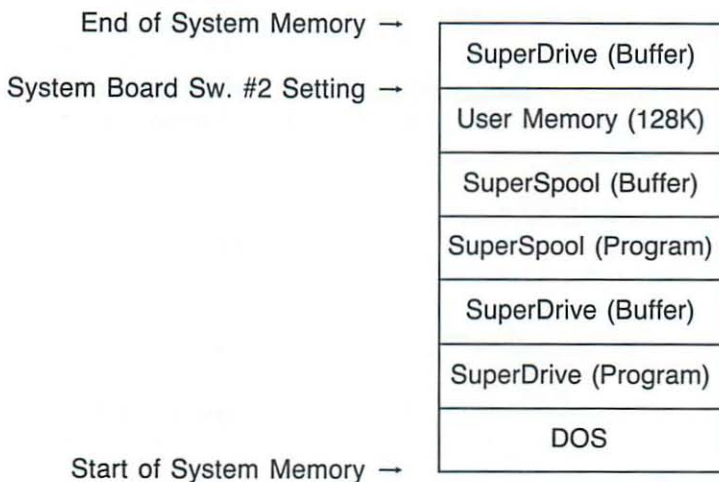

EXAMPLE 5

Your PC-1 is "maxed out" with 832K of memory installed, including 192K of noncontiguous memory with the location beginning at address :C0000. You want to create two single-sided SuperDrives, and use whatever is left for SuperSpool. But this time, you don't want to utilize any part of contiguous memory available above the limit of the switches; you want to use only noncontiguous memory, followed by low memory.

```
SUPERDRV C:/1/U = 128/DH  
SUPERDRV D:/1/U = 128/DH  
SUPERSPL LPT1:/U = 128/M/DH
```

Noncontiguous memory at address :C0000 will be used first, followed by low memory, with the user area ending up being displaced upward to the switch limits. Contiguous memory above the limits of the switches is not used.

The following diagram illustrates memory allocation in Example 5 (including full system memory map for reference).

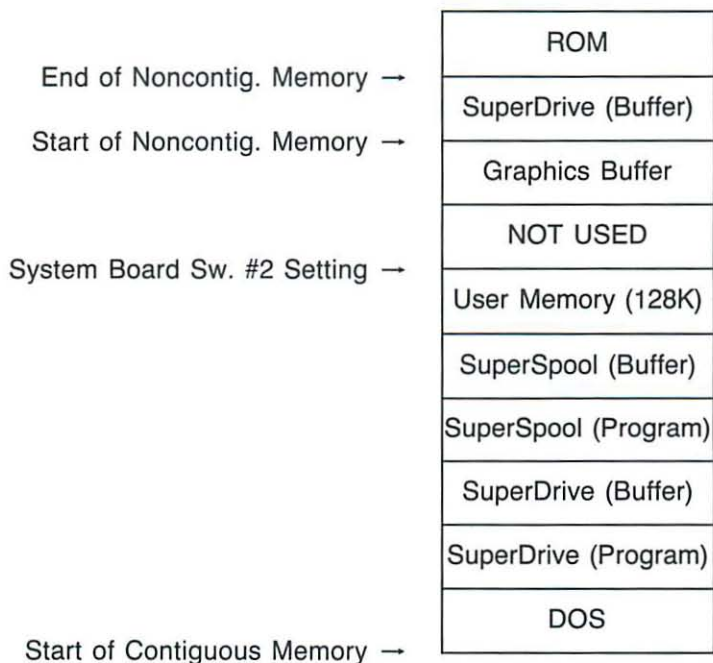

(This page intentionally left blank)

SECTION 6

RAMCLEAR

When a PC-1 or PC-2 is first powered up, it will perform a memory diagnostic on all RAM, up to the memory limit set by system board switch #2. This powerup diagnostic actually serves two purposes:

1. To test memory for correct operation
2. To purge out any stray parity errors which may exist.

However, any memory that exists in the computer above the switch settings (up to address :9FFFF or between addresses :C0000 and :EFFFF) will not be parity purged and may generate false parity errors if a memory read is attempted in those address ranges.

The RAMCLEAR.COM program initializes these memory areas so that false parity errors do not occur. To invoke the RAMCLEAR program, type in a command using this format:

```
RAMCLEAR [/DH]/[DNC] <Enter>
```

You can include the /DH and /DNC parameters in the RAMCLEAR command line. The correct syntax is:

```
RAMCLEAR [/x]
```

where *x* refers to the /DH and /DNC parameters described below. You can specify the parameters one after the other; do not use a space or a comma to separate parameters. A slash (/) must precede each parameter in the command.

You can run RAMCLEAR by simply entering this command from the DOS prompt:

RAMCLEAR <Enter>

This assumes that you have copied the RAMCLEAR.COM program from the SuperPak master diskette onto your working DOS diskette. You can also make RAMCLEAR a part of your AUTOEXEC file. In either case, RAMCLEAR should be the first command given at powerup; do not issue RAMCLEAR at any time after any other commands or programs.

[/DH] This option ("Disable High-Memory Use") prevents the RAMCLEAR program from initializing any portion of contiguous memory which might be available above the limit set by the system board switches (only the PC-1 and PC-2 have high memory). It does not, however, prevent RAMCLEAR from initializing any noncontiguous memory which may be present beginning at address :C0000 and up. It has no effect if there is no contiguous memory available above the switch settings.

[/DNC] This option ("Disable Noncontiguous Memory Use") prevents the RAMCLEAR program from initializing any noncontiguous memory which may be available beginning at address :C0000.

Please note that RAMCLEAR will perform no useful function in a PC-XT or Portable PC because the computer will automatically see and initialize all user RAM. Also note that for the PC-2, PC-XT, or PC-1 (with the new ROM BIOS supplied with the IBM hard disk add-on), IBM does not recommend support for user memory between addresses :C0000 and :EFFFF.

The RAMCLEAR program has no effect on the normal parity error detection capability of the hardware.

APPENDIX A

GUIDE TO TERMINOLOGY

Refer to your IBM Personal Computer manuals for an explanation of terms or concepts related to DOS functions (AUTOEXEC.BAT files, batch files, DOS commands, default drive, etc.).

Application program: The program the user is going to run after setting up SuperDrive and/or SuperSpool. This could be a word processor, general ledger, or any other software. To prevent SuperDrive and SuperSpool from disturbing the application program, use the /U = xxx option to reserve an area of memory for it.

Buffer portion: The data storage area of memory used by either SuperDrive or SuperSpool, as opposed to the resident (program) portion. The size of this area of memory is controlled by the /M or /M = xxx option.

Contiguous memory: Memory in the 640K range from hex 00000 to 9FFFF, with no gaps. Memory below the limit set by the system board switches is referred to as "low memory"; memory above the limit set by the switches is referred to as "high memory". The PC-XT and Portable PC can have only contiguous, low memory.

Logical disk drive: An electronic disk drive being simulated in memory space by SuperDrive software.

Noncontiguous memory: Memory in the 192K range from :C0000 to :EFFFF. This memory is available in the PC-1 when using the MegaPlus II and 256K MegaPak with the Split Memory Addressing function enabled. You cannot use the noncontiguous memory in the PC-2, PC-XT, Portable PC, or a PC-1 with the new ROM BIOS installed.

Physical disk drive: A mechanical floppy disk drive (not a SuperDrive).

Resident portion: The program portion of either SuperDrive or SuperSpool, as opposed to the portion used for storing data (the buffer portion). Also refers to the program portion of the DOS MODE command used by SuperSpool.

User area: The area of memory set aside for the application program by SuperDrive and SuperSpool via the /U = xxx option. SuperDrive and SuperSpool will not disturb this area of memory. This area will never be less than 64K in size.

APPENDIX B

PATCHING DOS FOR ADDITIONAL DRIVES

SuperDrive normally requires you to set DIP switch SW1 on your IBM PC system board for the total number of floppy drives including SuperDrives. Under certain circumstances, you might prefer to leave the switch set for the actual number of physical drives in the computer. For example, single drive users may want to leave the switch set for only one drive to avoid problems when COPYing file-by-file.

We recommend that you change the system board switch so that you do not have to make permanent patches to DOS. This helps maintain a high degree of compatibility between SuperDrive and other application software.

As an alternative to changing the system board switch, you may want to make the following patches to DOS itself. The main disadvantage of this method is that you now must maintain two different versions of DOS; one patched version for use with SuperDrive, and a separate version for use without SuperDrive. We don't recommend making patches to DOS; if you do, you run the small risk of creating incompatibility with other software which might also require patching DOS.

This appendix presents three DOS patch procedures; the procedure you use depends on whether you are patching PC-DOS 1.1, PC-DOS 2.0, or PC-DOS 2.1. Never make patches to your original PC-DOS master diskette! Use only working copies. After making the patch, be sure to make a notation on the diskette label (and on subsequent copies of the patched diskette) that it has been modified.

These procedures assume that a PC-DOS 1.1 diskette contains the DOS 1.1 version of DEBUG.COM, that a PC-DOS 2.0 diskette contains the DOS 2.0 version of DEBUG.COM, and that a PC-DOS 2.1 diskette contains the DOS 2.1 version of DEBUG.COM.

You enter all **boldface** text. Unless otherwise specified, use the spacebar between keyboard entries. Note that at two points in each procedure, you will make a selection from the following tables (values "xx" and "yy"), depending on whether your system board switches are currently set for one or two drives, and also depending on how many drives you want DOS to see after the patch.

**Switches Set for
One Drive**

xx = 40 2 Drives
xx = 80 3 Drives
xx = C0 4 Drives

yy = 02 2 Drives
yy = 03 3 Drives
yy = 04 4 Drives

**Switches Set for
Two Drives**

xx = C0 3 Drives
xx = 80 4 Drives

yy = 03 3 Drives
yy = 04 4 Drives

Patching PC-DOS 1.1 for Additional Drives

Boot the computer with a DOS 1.1 diskette containing DEBUG.COM.

A>**DEBUG**<Enter>

-L100 0 7 2<Enter>

If patching single-sided DOS diskette

or

-L100 0 142 2<Enter>

If patching double-sided DOS diskette

-E34F <Enter>

04FA:034F D0.2B (Space—Debug goes to next line)

04FA:0350 C0.C0 25.1E 03.8E 00.D8 75.80 06.36
C6.10 06.04

04FA:0358 01.xx 04.1F 01.B8 40.yy 40.00 <Enter>

-W100 0 7 2 <Enter> If patching single-sided DOS
diskette

or

-W100 0 142 2 <Enter> If patching double-sided DOS
diskette

-Q <Enter>

A> <Ctrl-Alt-Del> Reboot the computer

Patching PC-DOS 2.0 for Additional Drives

Boot the computer with a DOS 2.0 diskette containing
DEBUG.COM.

A> DEBUG <Enter>

-L100 0 D 1 <Enter> For single-sided, 9-sector DOS
diskette

or

-L100 0 10 1 <Enter> For double-sided, 9-sector DOS
diskette

-A10D <Enter>

XOR SI,SI <Enter>

PUSH SI <Enter>

POP DS <Enter>

XOR BYTE PTR [410],xx

PUSH CS <Enter>

PUSH CS <Enter>

POP DS <Enter>

POP ES <Enter>
MOV WORD PTR [SI],71B <Enter>
POP AX <Enter>
MOV AL,yy <Enter>
NOP <Enter>
<Ctrl-Break>

-W100 0 D 1 <Enter> For single-sided, 9-sector DOS
diskette

or

-W100 0 10 1 <Enter> For double-sided, 9-sector DOS
diskette

-Q <Enter>

A> <Ctrl-Alt-Del> Reboot the computer

Patching PC-DOS 2.1 for Four Drives

Boot the computer with a DOS 2.1 diskette containing
DEBUG.COM.

A> DEBUG <Enter>

-L100 0 D1 For single-sided, 9-sector DOS
diskette

or

-L100 0 B1 For single-sided, 8-sector DOS
diskette

or

-L100 0 10 1 For double-sided, 9-sector DOS
diskette

or

-L100 0 E 1 For double-sided, 8-sector DOS
diskette

```
-A18A <Enter>  
XOR SI,SI <Enter>  
PUSH SI <Enter>  
POP DS <Enter>  
XOR BYTE PTR [410],xx <Enter>  
PUSH CS <Enter>  
PUSH CS <Enter>  
POP DS <Enter>  
POP ES <Enter>  
MOV WORD PTR [SI],798 <Enter>  
POP AX <Enter>  
MOV AL,yy <Enter>  
NOP <Enter>  
<Ctrl-Break>
```

-W100 0 D 1 <Enter> For single-sided, 9-sector DOS
diskette

or

-W100 0 B 1 <Enter> For single-sided, 8-sector DOS
diskette

or

-W100 0 10 1 <Enter> For double-sided, 9-sector DOS
diskette

or

-W100 0 E 1 <Enter> For double-sided, 8-sector DOS
diskette

A> <Ctrl-Alt-Del> Reboot the computer

(This page intentionally left blank)

AST RESEARCH, INC.

Product Comment Form

SuperPak User's Manual

000114-001 A

We appreciate your comments regarding any problems or suggestions related to AST Research products. Please use this form to communicate any observations that you have concerning the improvement of either the product itself or the product documentation provided in this manual.

Submitter Information

Submitter's name:

Address:

Product/Manual Comments and Suggestions

Please mail this form to:

AST Research, Inc.
Attn: Technical Publications
2121 Alton Avenue
Irvine, CA 92714



LIMITED WARRANTY

AST Research, Inc. warrants to the original purchaser of this AST Research, Inc. product that it is to be in good working order for a period of one year from the date of purchase from AST Research, Inc. or an authorized AST Research, Inc. dealer. Should this product, in AST Research, Inc.'s opinion, malfunction during the warranty period, AST will, at its option, repair or replace it at no charge, provided that the product has not been subjected to misuse, abuse, or non-AST authorized alterations, modifications, and/or repairs.

Products requiring Limited Warranty service during the warranty period should be delivered to AST with proof of purchase. If the delivery is by mail, you agree to insure the product or assume the risk of loss or damage in transit. You also agree to prepay shipping charges to AST.

ALL EXPRESS AND IMPLIED WARRANTIES FOR THIS PRODUCT INCLUDING, BUT NOT LIMITED TO, THE WARRANTIES OF MERCHANTABILITY AND FITNESS FOR A PARTICULAR PURPOSE, ARE LIMITED IN DURATION TO THE ABOVE ONE YEAR PERIOD. Some states do not allow limitations on how long an implied warranty lasts, so the above limitations may not apply to you.

UNDER NO CIRCUMSTANCES WILL AST RESEARCH, INC. BE LIABLE IN ANY WAY TO THE USER FOR DAMAGES, INCLUDING ANY LOST PROFITS, LOST SAVINGS, OR OTHER INCIDENTAL OR CONSEQUENTIAL DAMAGES ARISING OUT OF THE USE OF, OR INABILITY TO USE, SUCH PRODUCT. Some states do not allow the exclusion or limitation of incidental or consequential damages for consumer products, so the above limitations or exclusion may not apply to you.

THIS WARRANTY GIVES YOU SPECIFIC LEGAL RIGHTS, AND YOU MAY ALSO HAVE OTHER RIGHTS WHICH MAY VARY FROM STATE TO STATE.

The limited warranty applies to hardware products only.

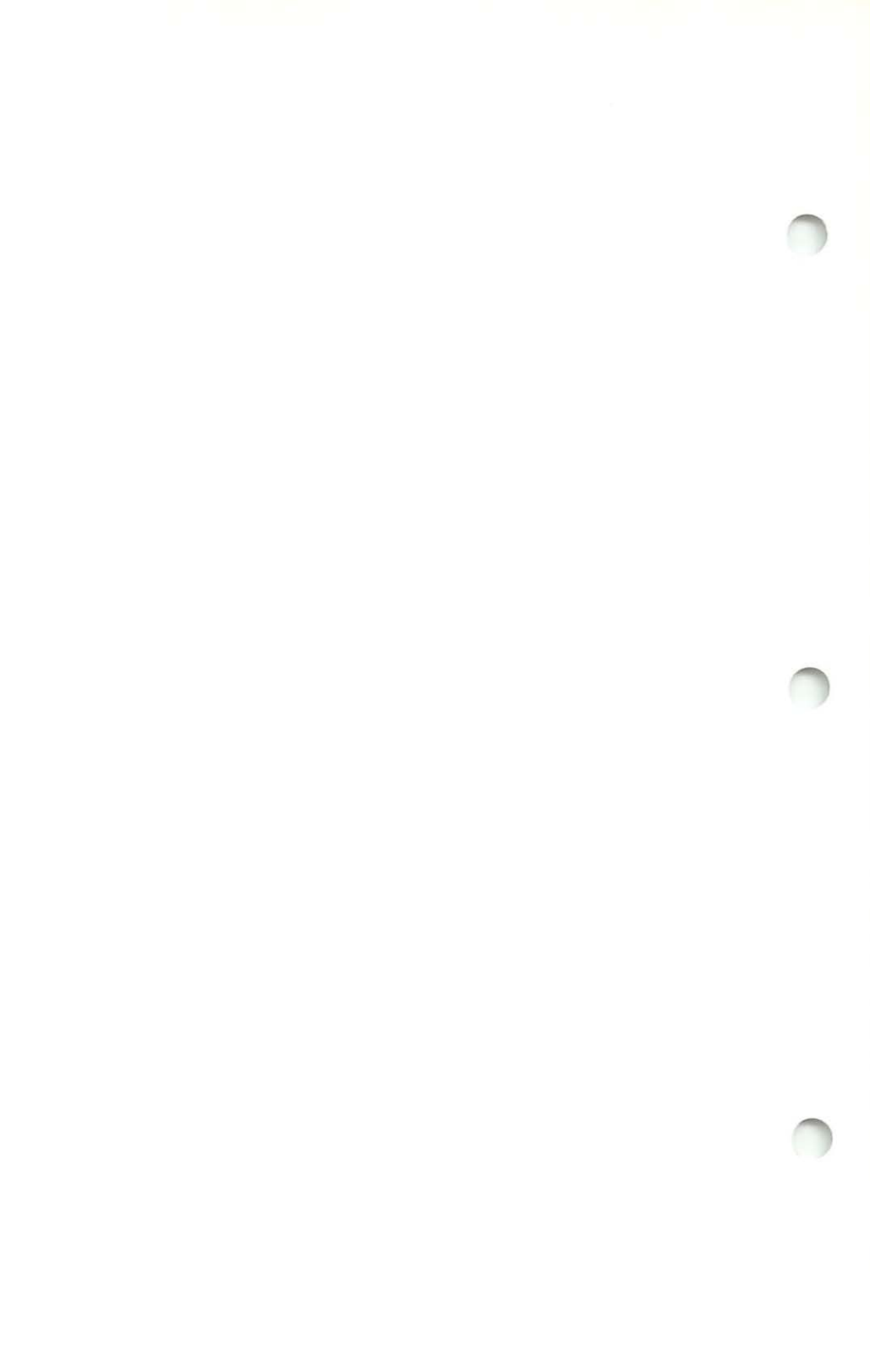



000114-001 B

PRODUCT REPAIR PROCEDURE

If your AST Research product ever requires repair, contact your dealer first. The dealer from whom you originally purchased the product can usually service the product. If you must return a hardware product to the factory for service, follow these guidelines to ensure rapid, accurate turnaround:

1. *Call AST Research Technical Support for a Return Authorization Number (RAN):* A technician will discuss the problem with you; if factory service is required, the technician will give you a Return Authorization Number (RAN). Always refer to the RAN when you return anything for service. AST Research will return anything without a RAN to the sender.
2. *If the product is covered under the one-year AST Research Limited Warranty:* There is no charge for parts or labor involved in the repair. Please include a copy of your original purchase receipt as the proof of date of purchase for all warranty repairs.
3. *If the goods are covered under the Extended (paid second year) Warranty:* There is no charge for parts or labor during the Extended Warranty period. Please include (1) a copy of the original purchase receipt and (2) a copy of the *validated* Extended Warranty Registration Card.
4. *If the product is not covered under a warranty:* There is a minimum charge of \$50 plus parts for each item returned. If the total cost of repair on any individual item exceeds \$75, we will contact you for your authorization. We will return the repaired product to you with the repair charges billed COD. If the cost of repairing an individual item exceeds \$75 and you do *not* authorize the charge (that is, if you decline the repair), the \$50 minimum labor charge still applies to that item and will be billed COD.

5. *Parts not covered under the warranty:* Dealer- or user-installed parts (such as RAM chips) are not covered under the terms of the warranty. Dealer-installed parts are warranted by the dealer; parts that you install are covered only by the parts suppliers' warranties. If we find that your dealer- or user-installed parts are defective, we can identify which parts are defective, but we will not replace parts unless you specifically authorize us to do so in writing when you send the board to us. The parts charges and any applicable labor charges will be billed COD.
6. *Describe the problem and return any related accessories:* Please include a brief but explicit written description of the problem when you return your AST product to the factory for repair. Also return any accessories that might relate to the problem. For example, if the the parallel port does not function correctly, be sure to return the parallel port adapter cable with the board.
7. *Be sure to provide a return shipping address that UPS can deliver to and include your RAN:* UPS cannot normally deliver to post office boxes. Reference the RAN issued to you by AST Technical Support on all correspondence. Securely package all materials to prevent shipping damage. Shipping charges must be prepaid; CODs will not be accepted. Ship the materials to the following address:

AST Research, Inc.
Customer Service—RAN xxxx
2722 Michelson
Irvine, CA 92715

8. Once your product is repaired, we will return it to you by UPS or UPS Blue Label service, whichever is appropriate for your geographical location. We will return items covered by warranty at our expense. Shipping costs and repair expenses for items not covered by warranty will be billed COD. If you prefer overnight service (UPS Red Label), the shipping charges will be billed COD. If you want us to ship Federal Express, please give us your Federal Express account number for billing purposes.